



ROOF & WALL FLASHING

ARCHITECTURAL DETAILING

D E S I G N G U I D E



ROOF & WALL FLASHING

ARCHITECTURAL DETAILING

This Design Guide has been prepared to assist architects and architectural draftspersons with the design and installation intricacies of detailing roof and wall flashing for metal cladding. Quality of a finished installation is dependent on good detailing.

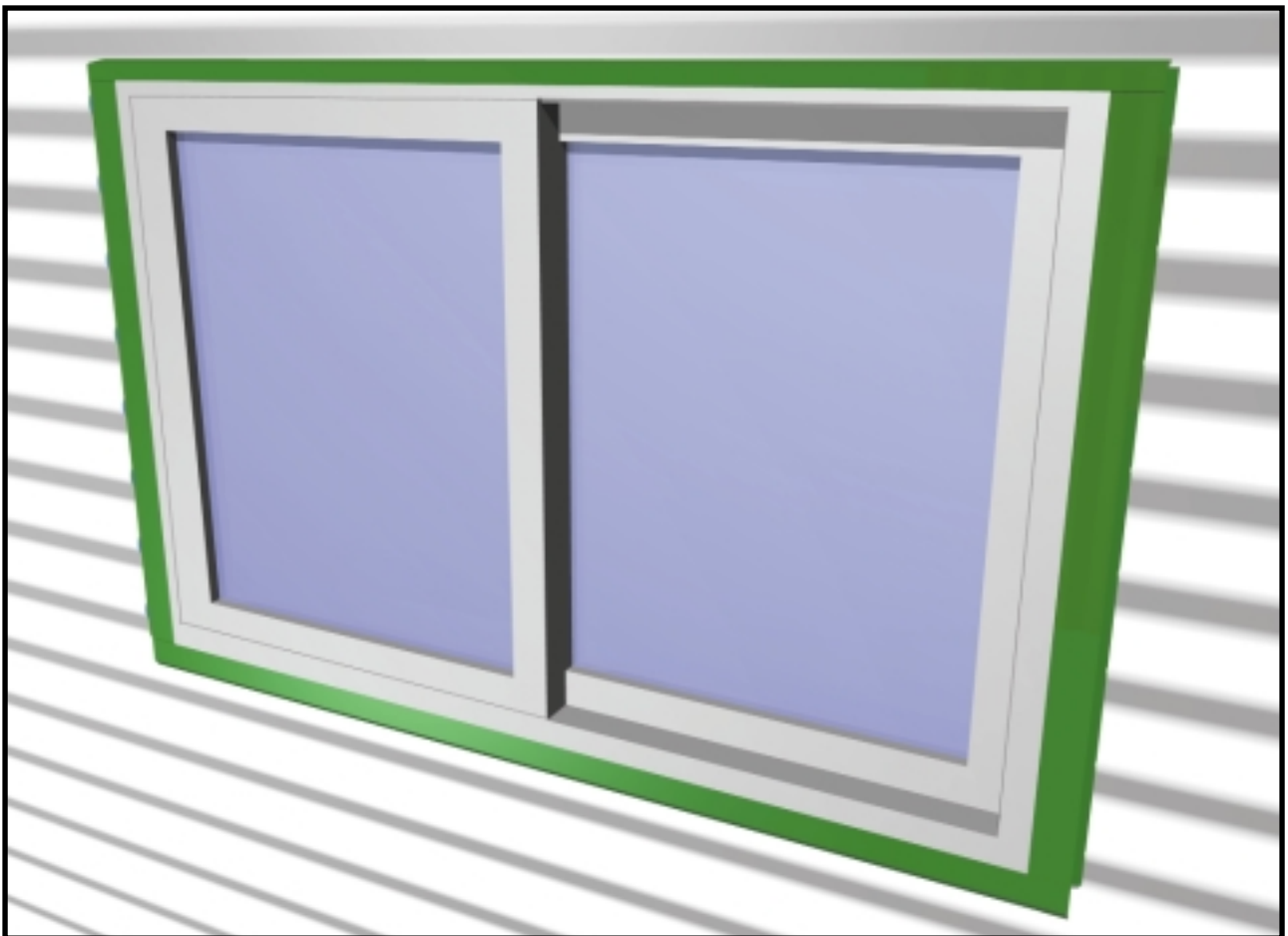

Important note

The information contained within this brochure is as far as possible accurate at the date of publication, however, before application in a particular situation, Stramit Building Products recommends that you obtain qualified expert advice confirming the suitability of product(s) and information in question for the application proposed. While Stramit Building Products accepts its legal obligations, be aware however that to the extent permitted by law, Stramit Building Products disclaims all liability (including liability for negligence) for all loss and damage resulting from the use of the information provided in this brochure.

Contents

Roof Flashing

Large Roof Penetration	8
Small Roof Penetration	8
Change of Pitch	8
Mansard	9
Expansion Joint	10
Ridge Capping	10
Raked Roof	11
Box Gutter	11
Barge Gutter	12
Barge Capping	12
Curved Barge	12
Parapet – Top	13
Parapet-to-sheet Connection	13

Wall Flashing

Mid-Wall Connections	14
Internal Corner – Trim	15
Internal Corner – Moulding	15
External Corner – Trim	16
External Corner – Moulding	17
Wall to Eaves/Soffit	18
Fascia Purlin	18
Bottom of Wall	19
Window/Door	20
Wall Penetrations	22

Introduction

This guide presents alternative methods of finishing metal-clad roofs and walls. In some instances flashing is best when almost invisible, and there are other cases where making a feature of flashing can enhance appearance. Renditions of some key aesthetic differences between alternatives have been included to show choices. In addition, commentary is made on aspects such as potential distortion around fixings. Important functional considerations have also been addressed where applicable.

As the details shown are applicable to a wide range of Stramit® Roofing and Walling profiles, only sample dimensions are given on each page. A section of the guide is dedicated to typical dimensions for a range of profiles, along with a number of advisory minimum and maximum values for specific applications.

The solutions given are typical only. Many real applications will require the adaptation of the ideas shown here, or the development of unique solutions using the principles set out in this guide.

Materials

Stramit® Roof and Wall Flashing is generally manufactured from G300 steel with protective coatings of Zinalume, galvanised or Colorbond XRW. Other materials, such as Colorbond Ultra, Colorbond Stainless, Uncoated Stainless, Copper and Aluminium are also available.

Colours

Stramit® Roof and Wall Flashing is available in a comprehensive range of colours, identical to those used for the sheeting. Contact your nearest Stramit office for colour charts or samples.

Durability

Selection of the correct materials in order to achieve the desired durability is important. This includes consideration of contact and water drainage between different materials. Extensive details of these durability considerations can be found in the *Stramit Premium Materials and Finishes Design Guide*.

Tolerances

Stramit® Flashing, whether standard or special, is manufactured to the same high standards and tolerances. Although normally produced within these values, assume the following tolerances when detailing flashing:

- fold to fold and fold to edge distances +/- 2mm
- overall length +/- 15mm
- bend angles +/- 2°
- out of straightness 2mm per m of length

Should tighter tolerances be required for a specific application please contact your nearest Stramit office.

Installation Skills

Flashing must be installed by a skilled tradesperson if quality results are to be achieved. This is particularly so for details such as door and window corners, and for flashing that has exposed fastenings. Careful design of flashing details to suit the application can help to ensure reliable function and a quality finish.

Cutting

Stramit® Flashing may be cut and trimmed easily on site using tin snips. All materials offered are either intrinsically durable or have sacrificial coatings that protect such cut edges in the same way as for the slit edges on the flashing.

Insulation

Flashing details should take into account any insulation (foil, blanket etc.) to be incorporated into the building element. For roofs, blanket greater than 50mm can cause complications with roof sheet fastening.

Stramit Speed Deck Ultra® concealed fixed decking can readily be installed with 75mm blanket and up to 100mm with care. Even greater thicknesses, and superior thermal isolation, can be achieved by the placement of Styrofoam blocks beneath the fixing clips.

Roof Overhangs

Although not a detail requiring the use of flashing, attention is drawn to the detailing of roof sheet overhangs. Stramit technical manuals give maximum overhangs for each roofing profile. For example corrugated sheeting has a 100mm maximum overhang when unstiffened and 200 to 300mm (depending on wind load category and steel grade) when stiffened by the attachment of a continuous supporting member such as an S-type gutter, a roof batten or a lipped angle.

Numerous instances have been observed of sheeting (often spring curved) being extended well beyond these limits. This is a safety hazard for persons walking on the roof (either during installation or at a later date) and must be avoided.

Ordering

Orders for **Stramit® Flashing** may be sent as a simple drawing showing each flat length in whole millimetres and the least angle between each flat in whole degrees. *Stramit Regional Price and Service Guides* contain illustrations of many common custom flashing arrangements. These can be adopted by referencing the custom flashing design number and writing the values for each letter and angle. Note that there are regional variations in these common custom flashing designs and their designations. Please contact your nearest Stramit office to obtain a copy of the *Price and Service Guide*.

Lead-time

Most **Stramit® Flashing** is made to order regardless of whether it is a standard design or custom designed. The manufacture and delivery times are aligned with those of roof and wall sheeting manufacture. Check with your nearest Stramit branch office for delivery times.

Girth Widths

Stramit® Flashing is made from (and hence costs are based on) a range of girth widths. These are generally from 100 to 500mm in increments of 50, thence 600, 800, 900, 1000 & 1200. It is suggested that, where practical, the girth width used for any flashing design is selected from this range, but this is by no means obligatory.

Scribing/Notching

Flashing covering the upper edge (eg ridge capping), or some side edges, of most roofing profiles is scribed or notched to ensure a close fit around the profile ribs. In some regions it has become common practice, with **Stramit® Corrugated** roof sheeting, to shorten the turn down leg to a nominal 10-15mm feather edge and leave this fully above the rib. This could have the effect of rubbing on the rib top, causing potential reduction in durability and sometimes roof noise. This approach also requires alternative means of reducing wind and wind-driven rain intrusion, and vermin-proofing (note that with either approach trough turn-ups are still needed). There may be applications where such a detail is appropriate. It is for the designer to specify whether full scribing is a requirement with flashing for profiled sheeting.

Roof and Wall Profiles

Stramit offers a wide range of roof and wall profiles. There are variations in this range between regions. The table below provides a guide to dimensions and availability of products in each State.

STRAMIT ROOF AND WALLING PROFILES – Availability and Nominal Dimensions (mm)												
roof/wall sheeting	regional availability								concealed fixing	rib spacing	profile height	profile cover
	V	NSW	WA	T	SQ	NQ	NT	SA				
Stramit Speed Deck Ultra®	■	■		■	■	■	■	■	■	233	43	700
Stramit® Corrugated	■	■	■	■	■	■	■	■		76	16	762
Stramit MonoClad®	■	■	■	■	■	■	■	■		190	27	762
Stramit MegaClad®	■	■		■				■		267	27	800
Stramit Longspan®	■	■	■	■	■	■	■	■		100	27	700
Stramit Speed Deck® 500	■		■	■				■	■	250	41	500
Stramit® SnaPtite	■								■	203	48	406
Stramit Paneldek® 200							■		■	203	38	203
Stramit Paneldek® 400						■			■	203	38	406
Stramit Xtraspan™ 900	available in any region by arrangement									127	38	890
Stramit K-Panel®	■	■		■	■			■		216	12	864
Stramit MonoPanel®	■	■		■				■	■		13	250
Stramit® C-Clad 200	■			■				■	■		15	203
Stramit® C-Clad 280					■	■			■		15	280
Stramit Minirib®		■				■					4	900
Stramit Mini Corry®		■		■	■	■	■	■			6	825
Stramit Lo-Clad™					■					164	12	820

V – Victoria, NSW – New South Wales, WA – Western Australia, T – Tasmania, SQ – South Queensland, NQ – North Queensland, NT – Northern Territory, SA – South Australia

Dimensions

While each flashing design may be different, to suit different roof or wall sheeting and particular applications, there are elements common to each. Many of these detailed flashing design aspects are described below.

Edges

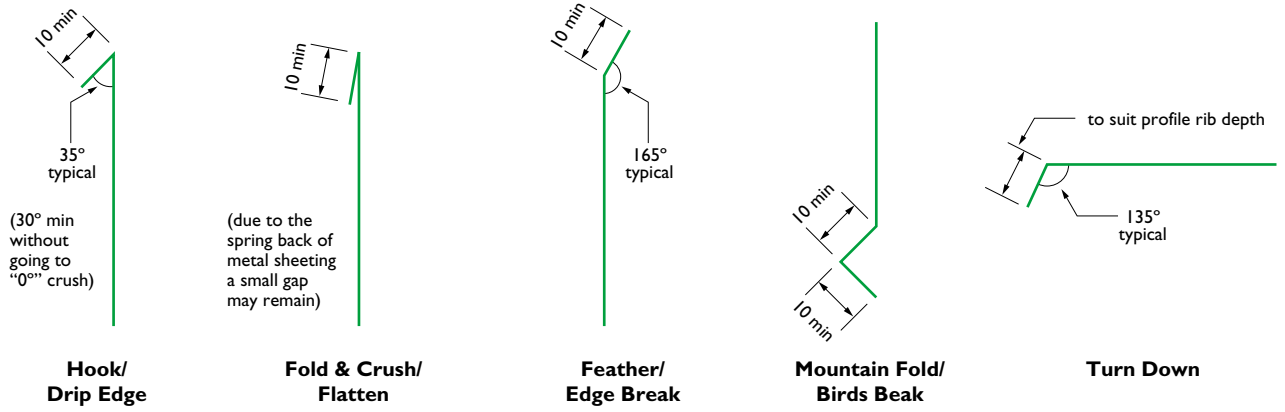

Laps

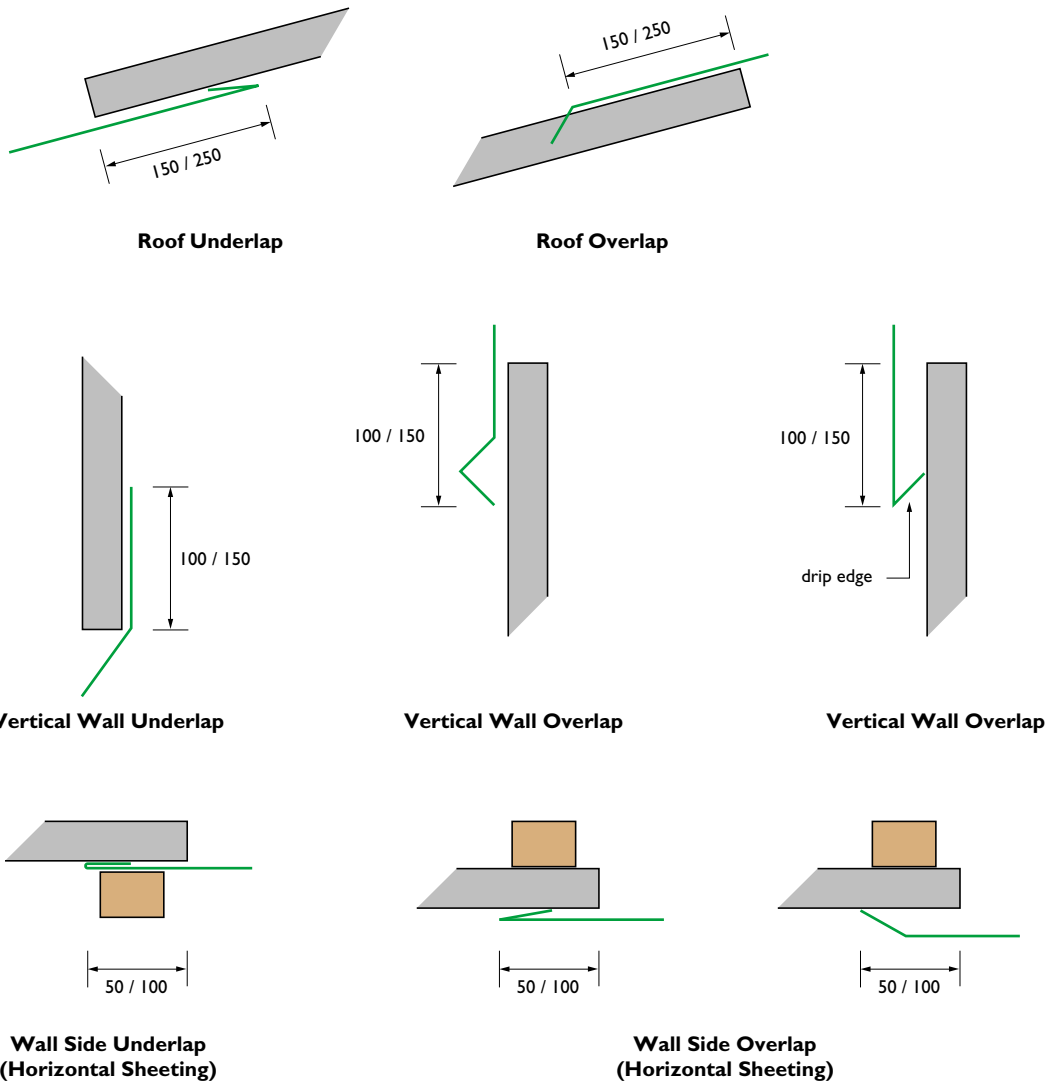

Laps

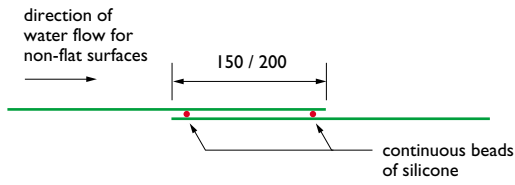

Flashing Straight Overlap

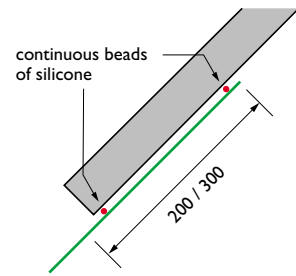

Sealed Roof Underlap (Soaker)

Other



Openings

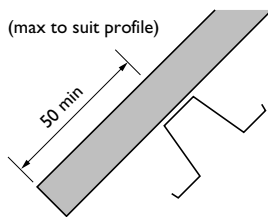

Sheet Overhang

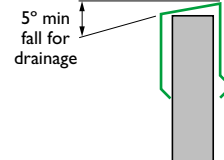
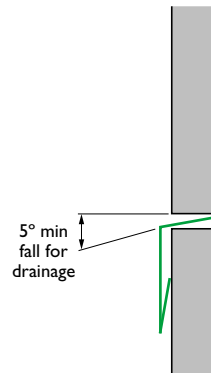

Drainage Allowance

Fixing

Flashing is generally fixed to cladding or other flashing sections using rivets or self-drilling screws. Fasteners close to folded edges generally cause the least distortion. Flashing edges beneath cladding normally only require nominal attachment to battens. Additional fixing may need to be considered in wind-exposed locations (eg. building corners).

General



Either timber or steel battens can be used



Indicates trough turn-up at sheet end

Large Roof Penetration

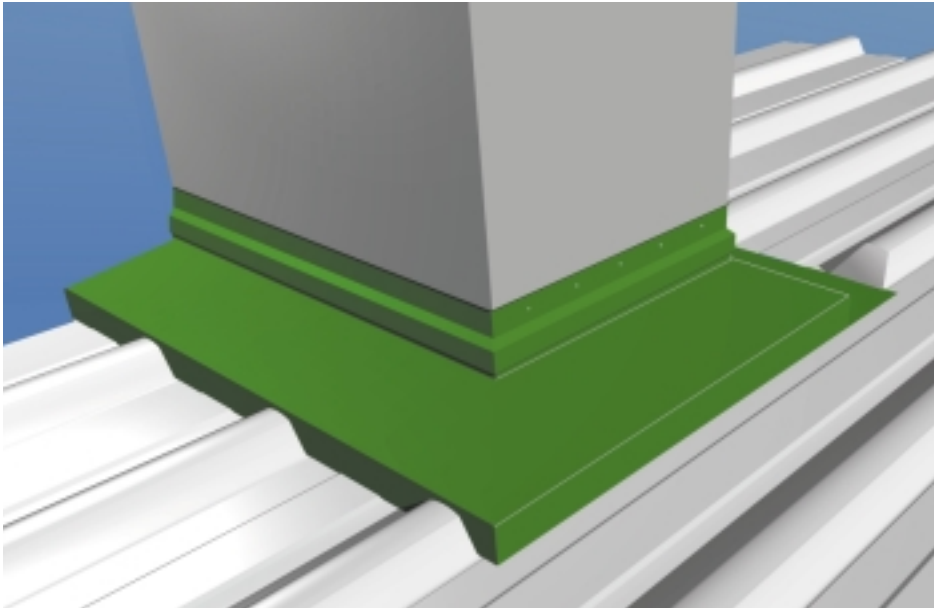

Large penetrations require considerable care in both flashing design and installation. The nature of the object penetrating the roof should be taken into consideration if it is subject to vibration, heat expansion, etc. Special attention is drawn to the need for an adequate drainage path at the front and sides of the penetration. For drainage design refer to the *Stramit Roof Slope Design Guide*.

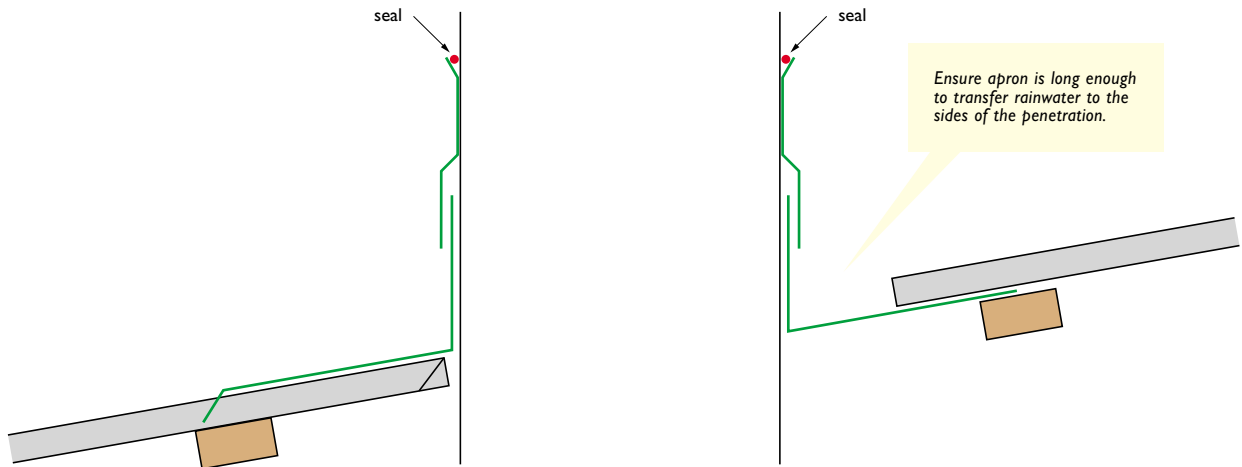

Small Roof Penetration

Smaller penetrations through roofs can be treated using the same principles as for larger penetrations. Proprietary flexible seals may be appropriate in some cases. It is important that these are installed in a manner that does not impede roof drainage or allow ponding. Roofing profiles with closely pitched ribs, eg., corrugated, invariably need a soaker arrangement to ensure adequate drainage.

Change of Pitch

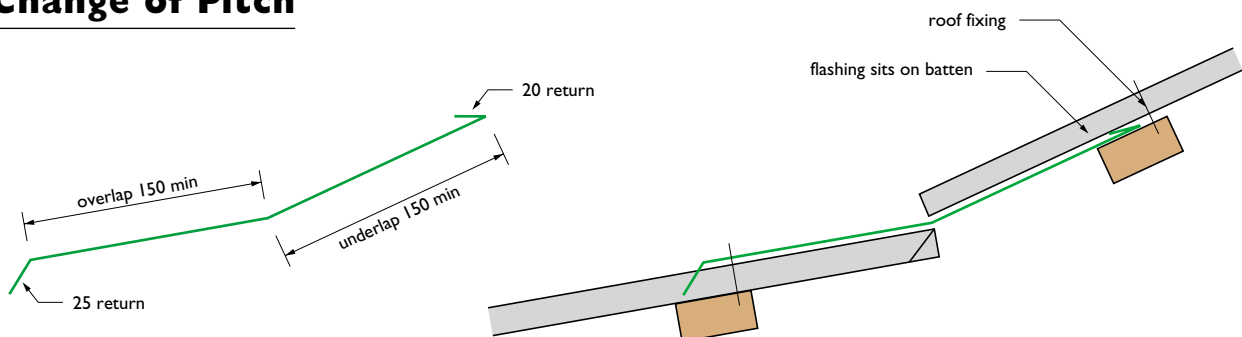

Ensure that the underlap length is sufficient to prevent wind-driven rain from entering. Similarly the roof sheet beneath the overlap must be turned up to avoid rain penetration.

Mansard

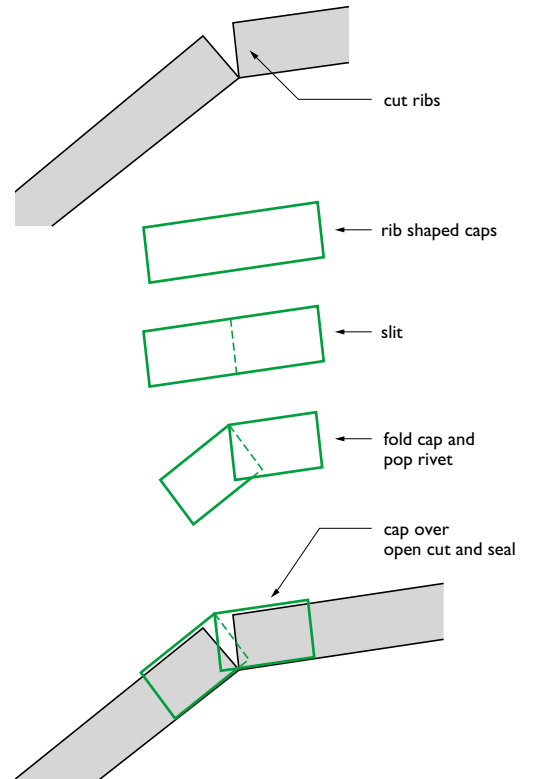

A mansard roof can be treated as a single sheet where the ribs are cut through, leaving the pans intact, with purpose-made caps covering the gaps in the ribs, as above. Alternatively, it can be considered as a change-of-pitch flashing as shown below.

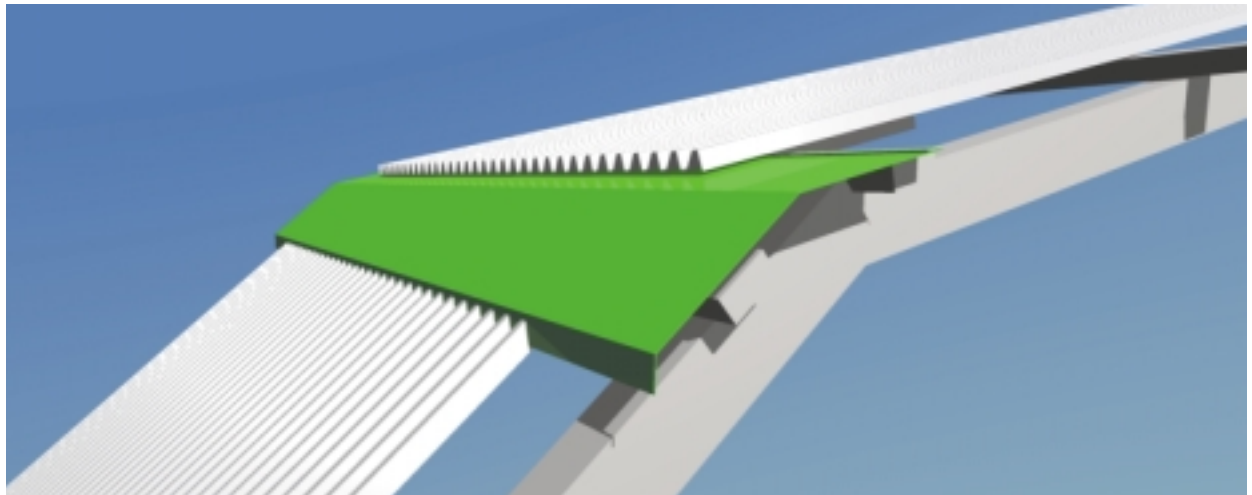

150mm is the recommended minimum overlap for slopes of 20° or less; for steeper pitches this may be reduced to as little as 50mm (in fully vertical applications).

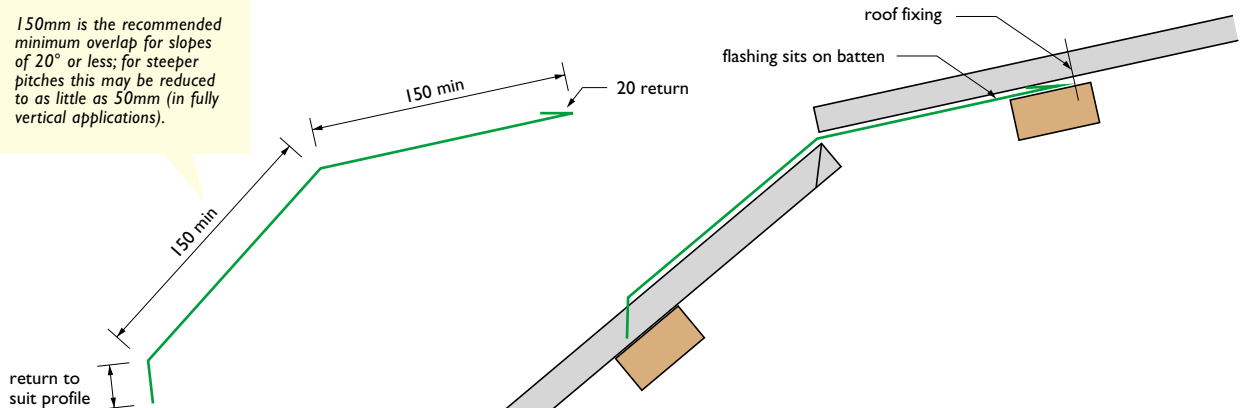

Expansion Joint

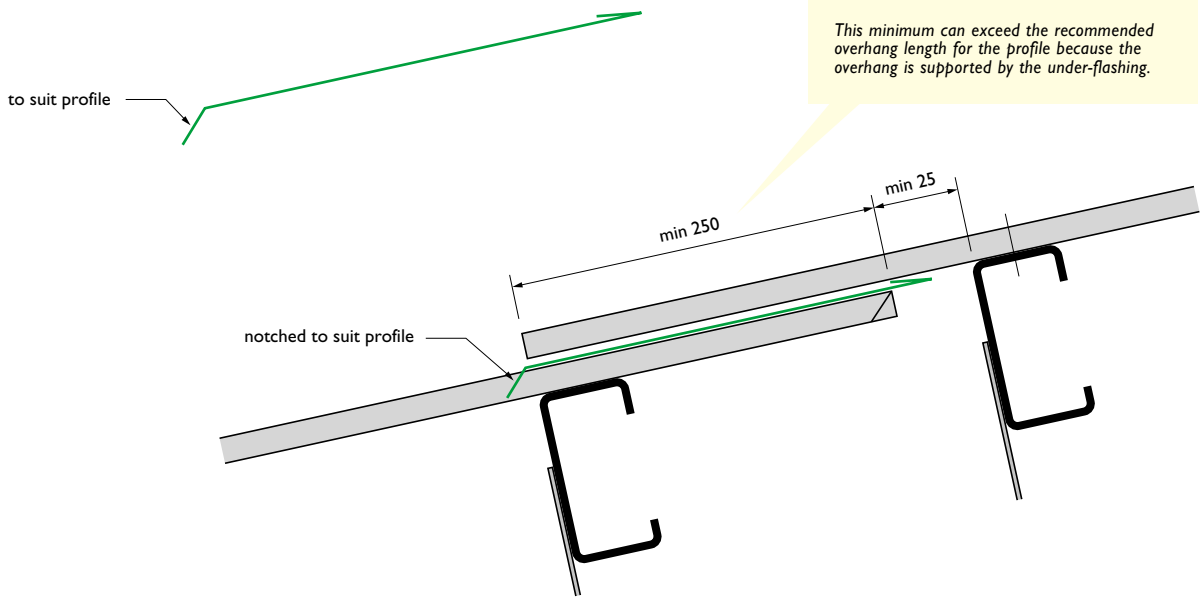

Expansion joints are incorporated into roof runs to reduce stresses on fastener connections. They are only required where the roof sheet length exceeds the values in the table below.

MAXIMUM SHEET LENGTH (m)			
	fixing method	sheeting colour	
		light	dark
straight	through-fixed	25	17
	concealed	35	25
spring-curved	through-fixed	20	17
	concealed	30	20

Note – temperature difference assumed to be 50°C for light colours and 75°C for dark.

Ridge Capping

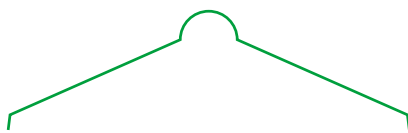

Roll-top ridge

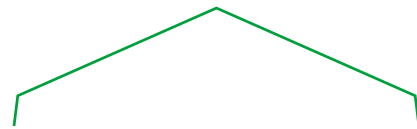

Plain or three-break ridge

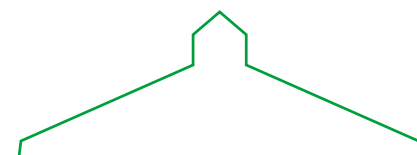
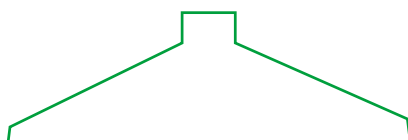

Stramit branches offer roll-top ridge and plain ridge as standard products. Other designs should be considered as custom flashings.

Raked Roof

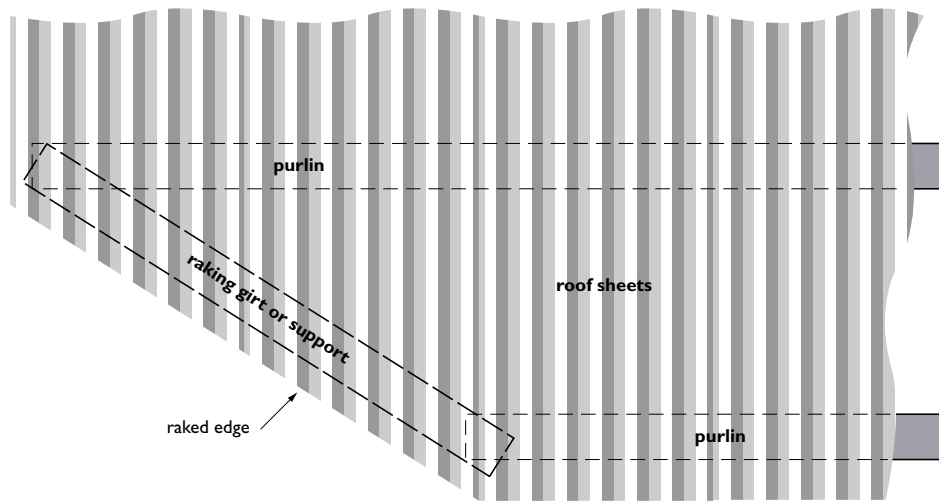

Raked roof edges occur where the roof sheet ends are cut at an angle to the line of the ribs. Some raked sheets will have insufficient end support from the purlins or battens. Where the overhang beyond the last supporting purlin exceeds the allowable overhang length for the profile, a sturdy support (eg. purlin or angle) must be provided. If flashing is used, such as a raking soaker, an underlap of 300mm or greater should be provided to prevent water penetration.

Box Gutter

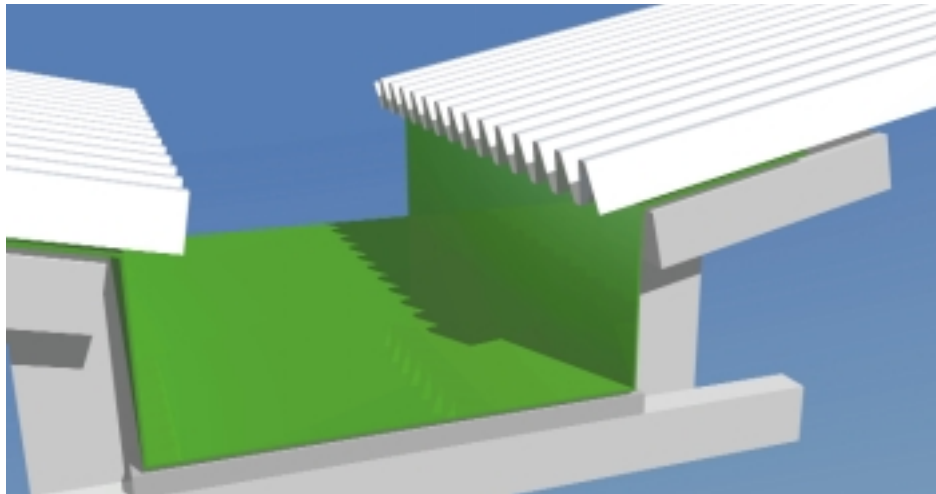

Box gutters have an important water drainage function and should be designed by an expert. Commercial box gutters must be at least 300mm wide and should be supported to allow for foot traffic during roof or service maintenance.

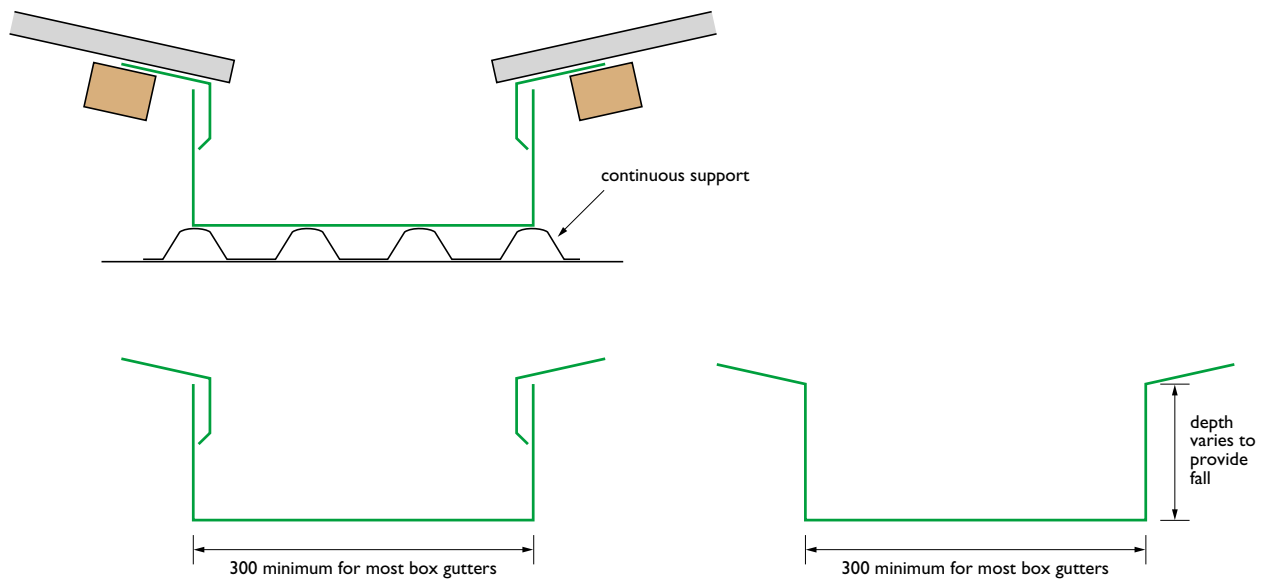

This options requires three sections of flashing. The top flashing should be deep enough to allow for fall in the box gutter.

This is a one-piece box gutter flashing with tapered side walls that increase in depth to provide drainage fall.

Barge Gutter

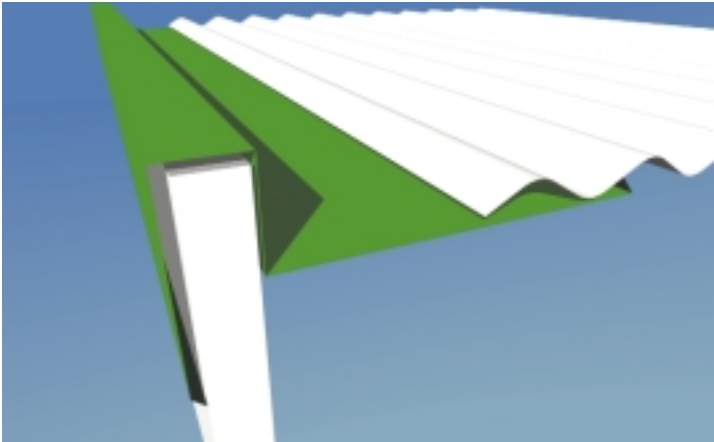

Barge gutters provide an alternative side detail for roofs, particularly tiled roofs. Usually these have only a limited drainage capacity, therefore avoid extra water flow from penetrations, etc.

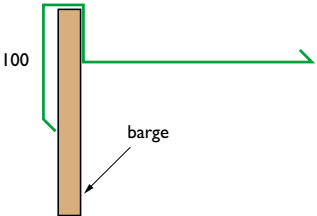

Barge Capping

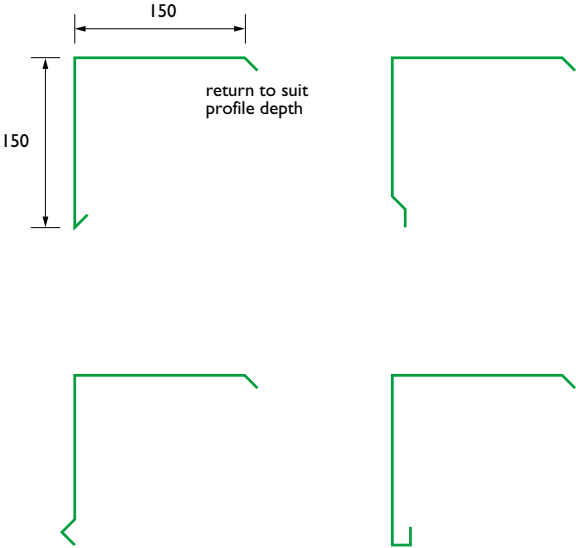
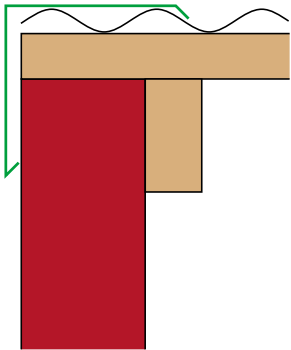

The most common sheet edge detail. Some Stramit branches offer standard barge capping to match square gutters.

Curved Barge

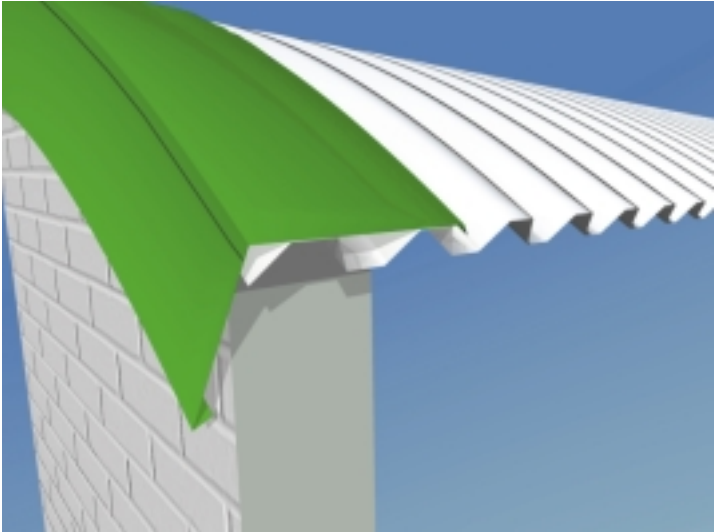

Curved sheet edges require a two-piece seamed barge capping.

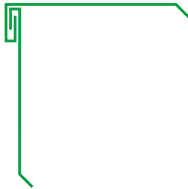

Parapet - Top

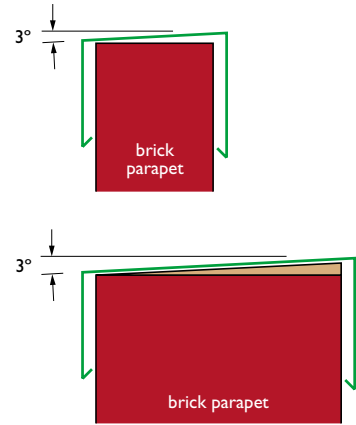
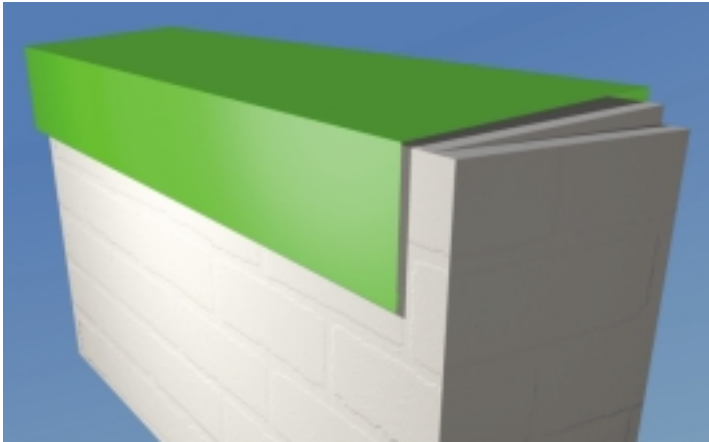

Parapet top flashing should be provided with a fall (minimum 3°) to avoid water ponding. For wider parapets, continuous support of the angled top surface may be required.

Parapet-to-Sheet Connection

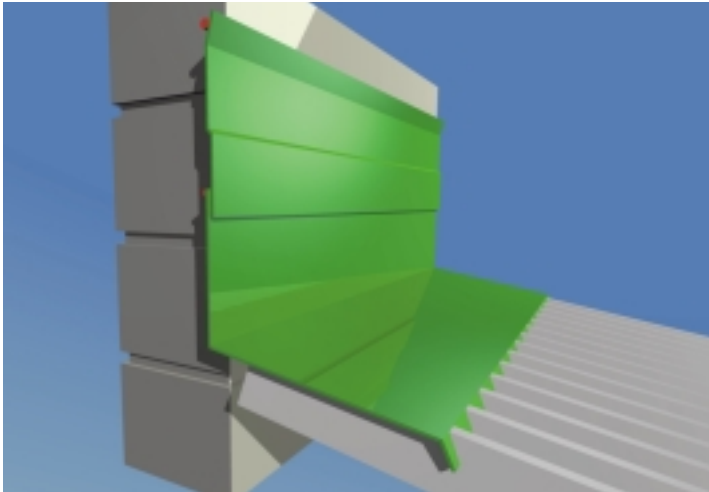

Parapet-to-sheet connections are often badly detailed and can be a cause of leakage. It is important that two overlapping sections of flashing are used, one attached to the parapet and one to the sheeting. Sealing is only required on the top section of flashing, which is not affected by thermal movement of the sheeting.

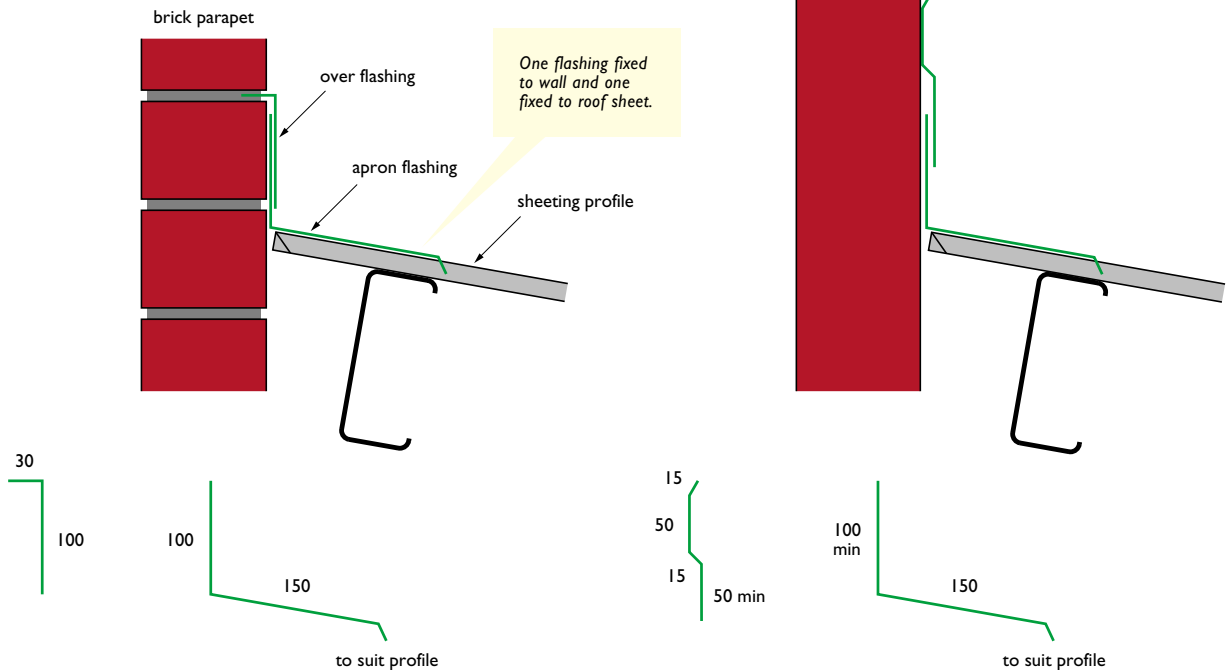

Mid-Wall Connections

Horizontal Sheeting Connections

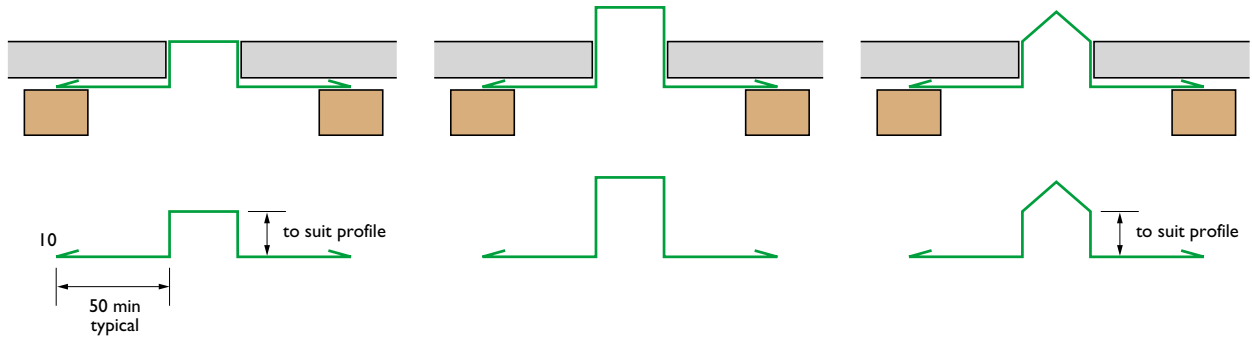
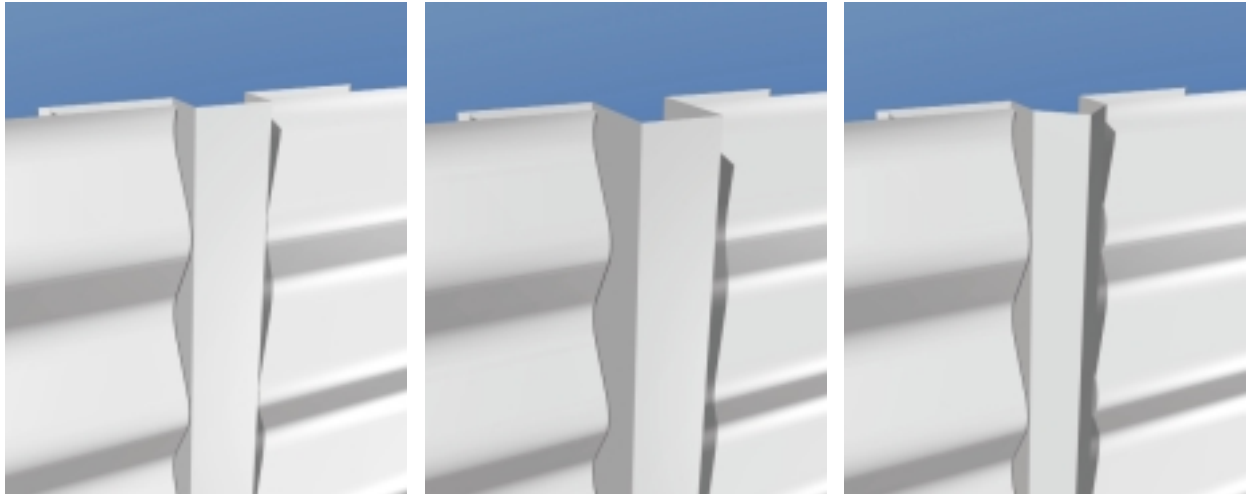

Above are three examples of mid-wall connections that make an attractive feature of horizontal sheeting joints. This type of connection joint is also reliable and easy to install. The best effect is generally achieved when the connections are spaced regularly along the wall. A typical spacing of 4 to 6 metres is particularly effective.

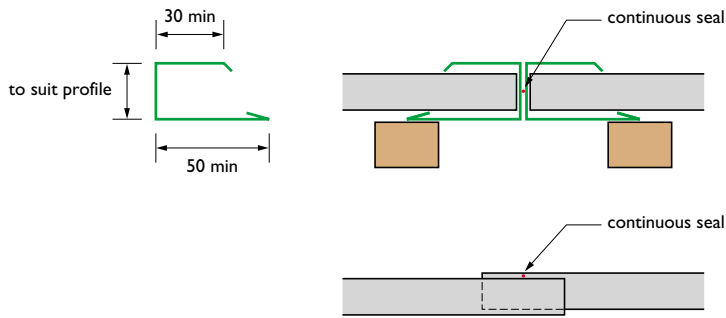

These alternative connections for horizontal sheeting require continuous sealing to maintain weather tightness.

Simple sheet overlap – only suitable for Stramit® Corrugated, Stramit Longspan®, Stramit Monoclad® or Stramit Megaclad® sheeting (not recommended if total combined sheet length exceeds 20 metres).

Vertical Sheeting Connection

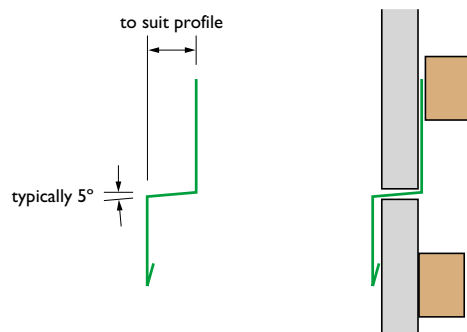

Internal Corner - Trim

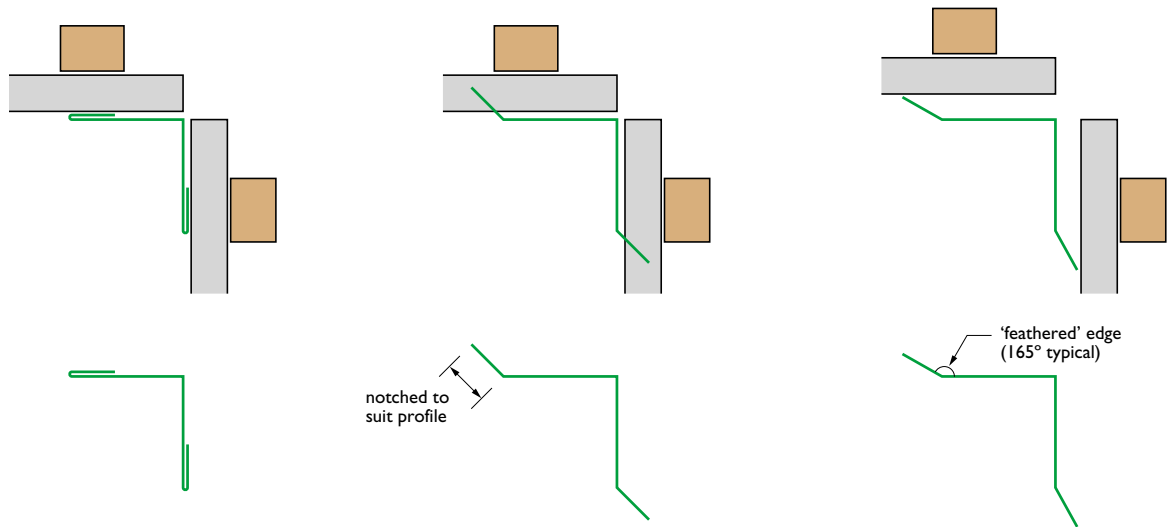

Internal corners can be treated with a simple trim for weather tightness or with a three-dimensional moulding for aesthetic effect. Internal corner trim may be used in vertical walling applications inside or outside a building. For internal corners with horizontal sheeting this trim should only be used inside a building (if exposed to the weather there is a risk of wind-blown rain penetrating the flashing). If appearance and function are equally important in a weather-exposed horizontal sheet application, the trim can be combined with an additional plain moulding to provide protection against rain penetration.

Internal Corner - Moulding

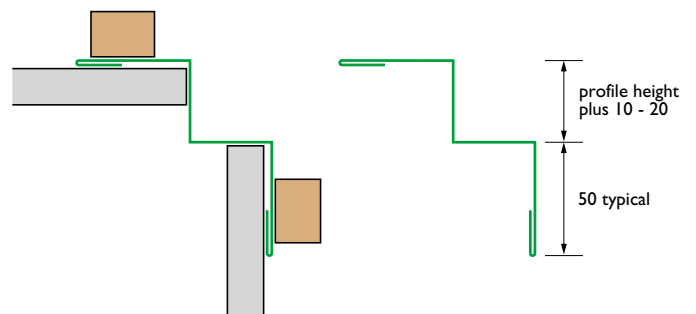
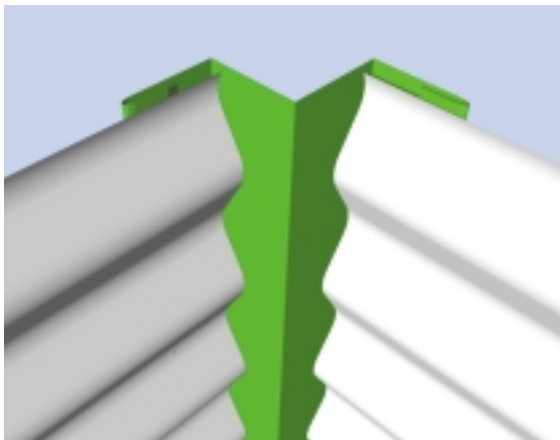
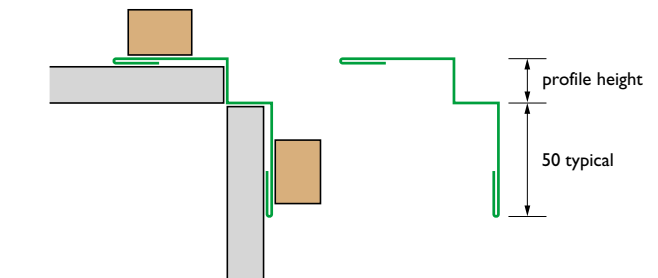
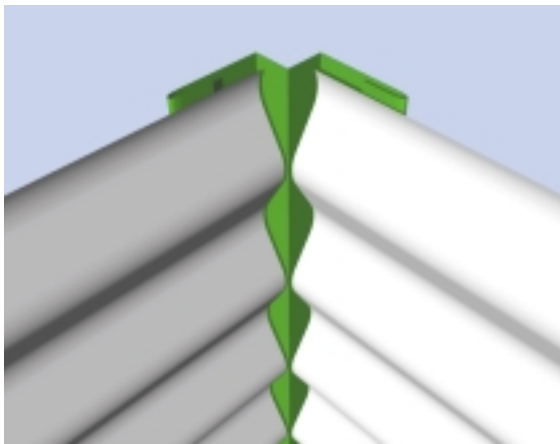

Internal corner mouldings may be used for inside or outside applications but are generally only used with horizontal sheeting. From the illustrations, it can be seen that a flashing with a step depth equal to the profile height relies on perfect alignment of sheeting on adjacent walls. Where the step depth is increased beyond the profile height, as in the lower illustration, the exposed flashing masks slight misalignments and provides a clean vertical edge that visually dominates the corner.

External Corner - Trim

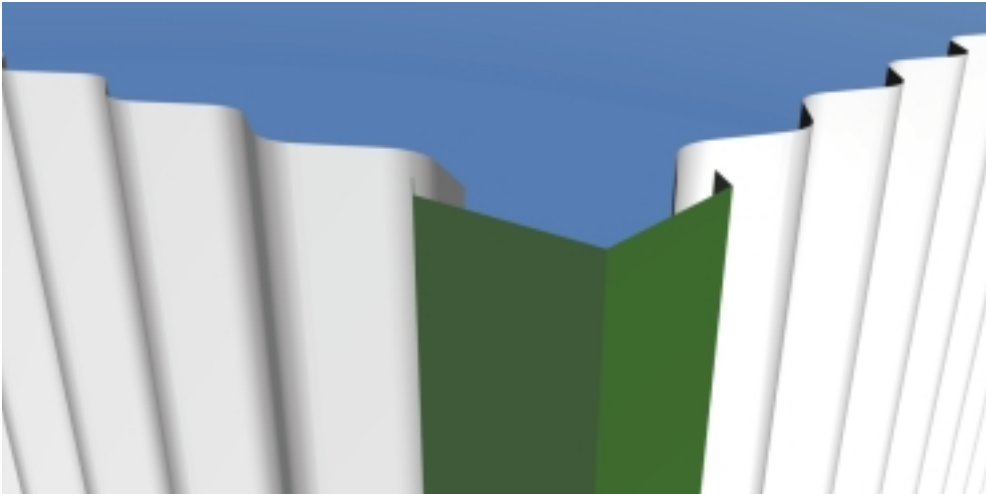

External corner trim shown with vertical Stramit® Corrugated sheeting.

External corner trims can take a number of forms, several of which are illustrated. Most can be used with either horizontal or vertical sheeting applications.

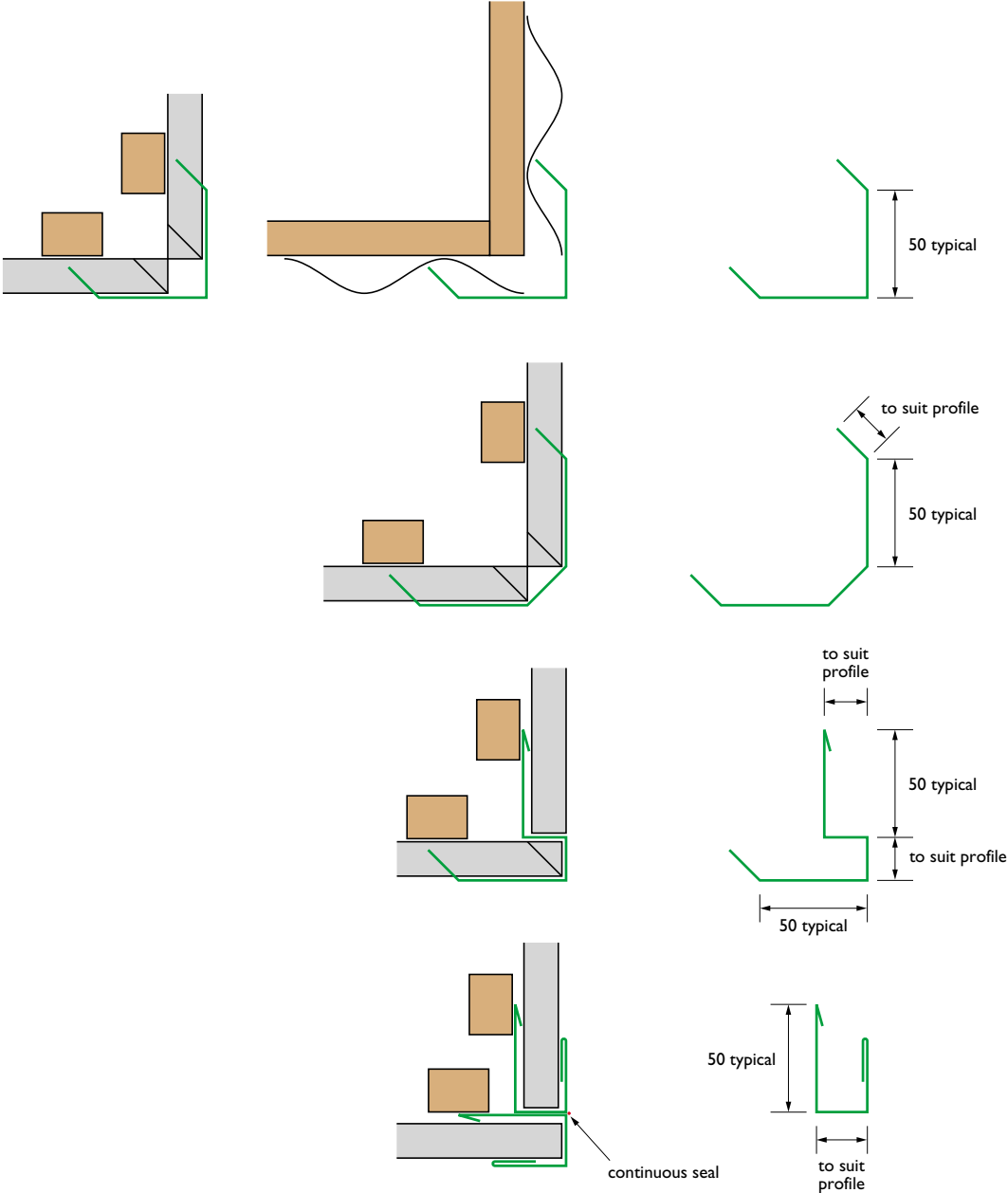

External Corner - Moulding

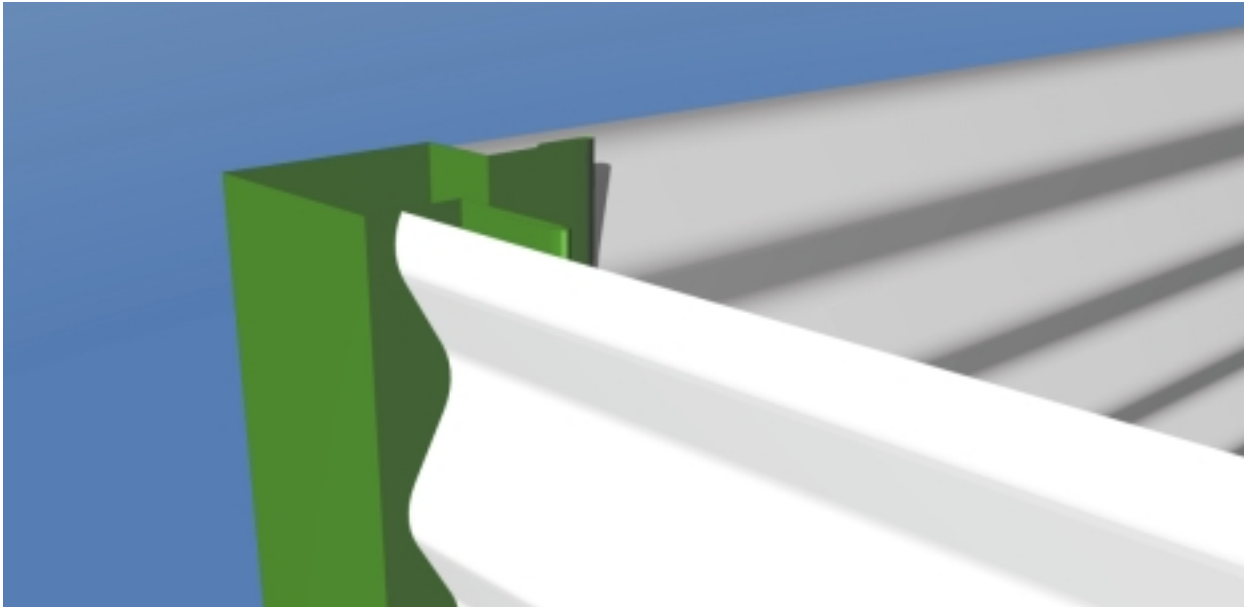

Flashing formed into a three-dimensional moulding provides an attractive finish on external corners, particularly with horizontal wall sheeting. A step depth greater than the profile height provides added protection to the sheet ends and is recommended for pedestrian areas.

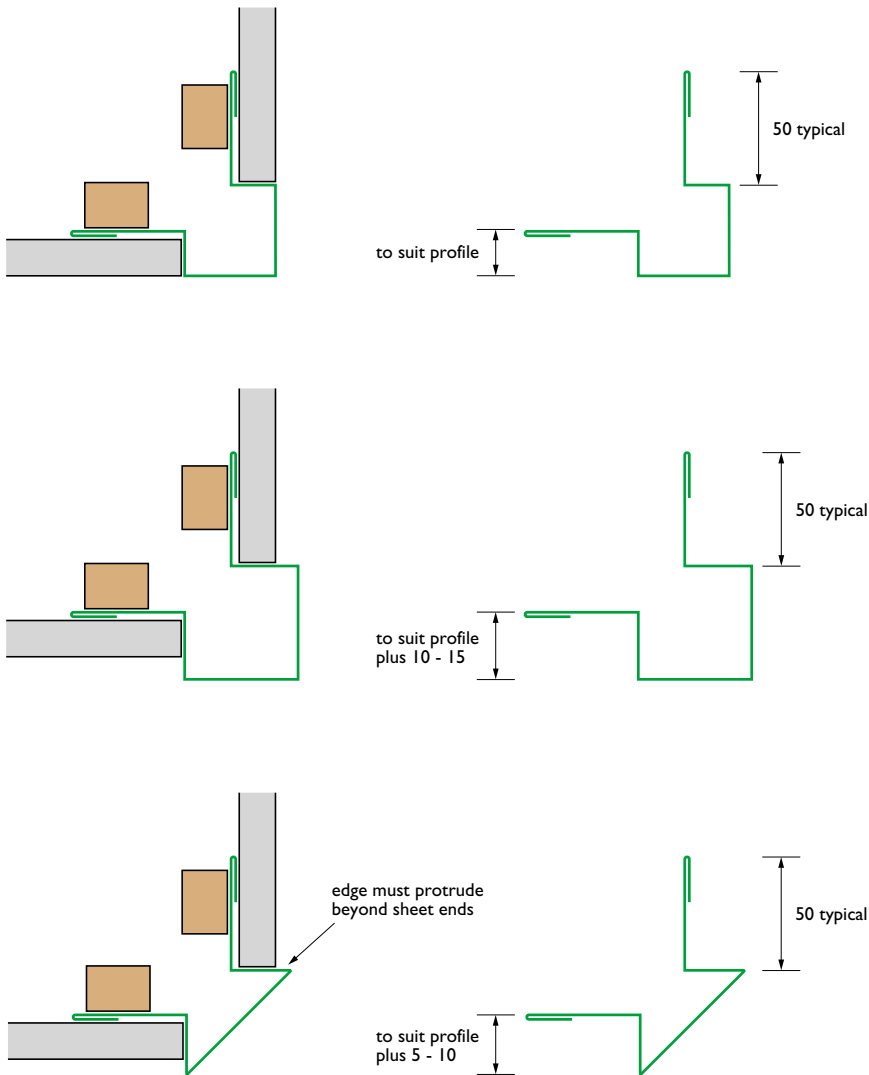

Wall to Eaves/Soffit

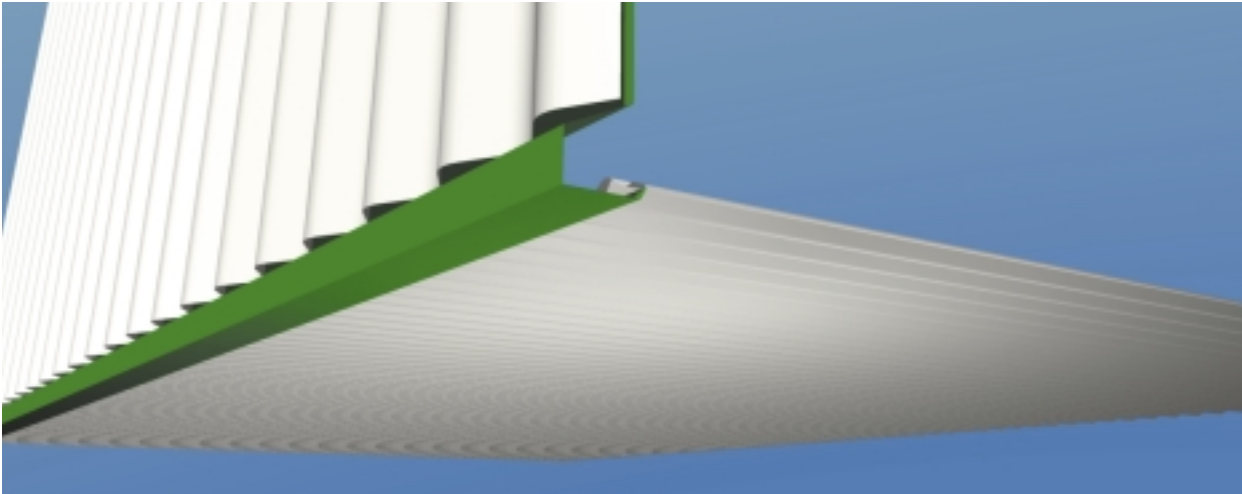

Typical flashing details for various wall, soffit and fascia intersections.

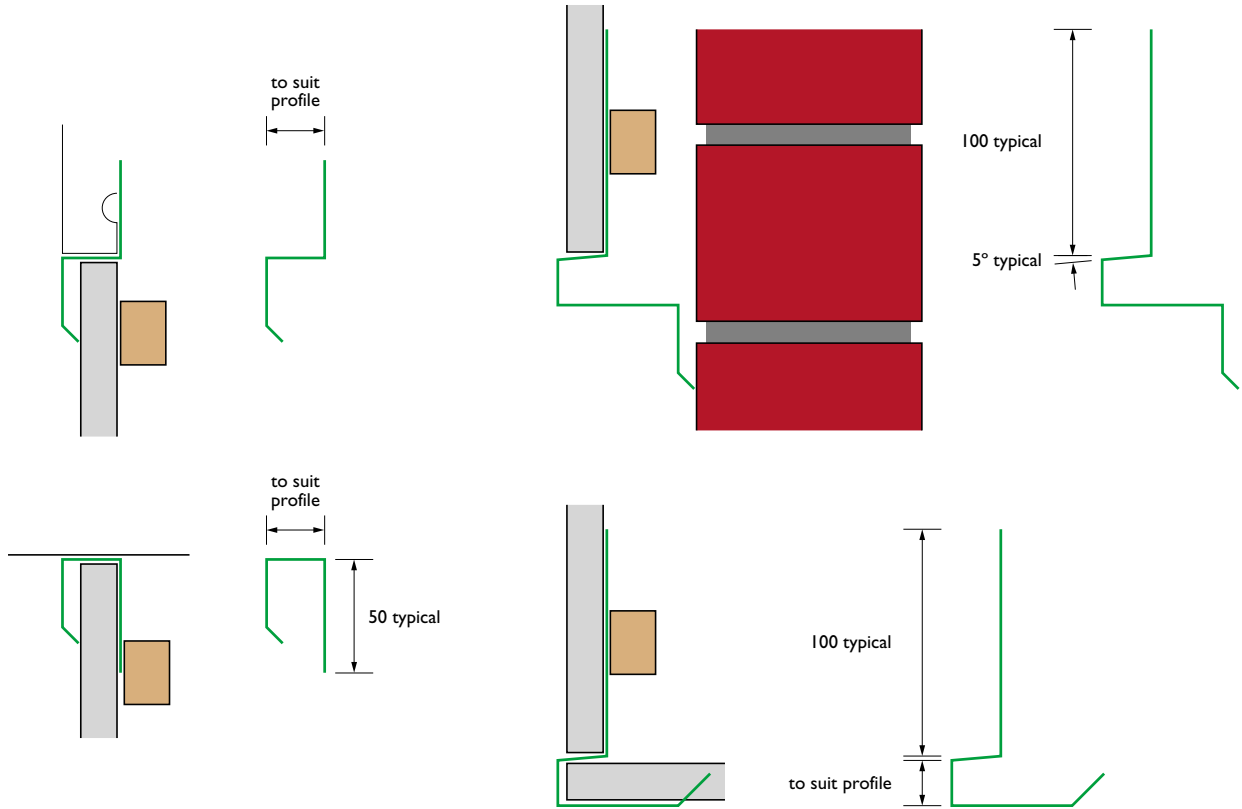

Fascia Purlin

A typical Stramit® Fascia Purlin. These are generally of a standard design but may vary slightly between regions.

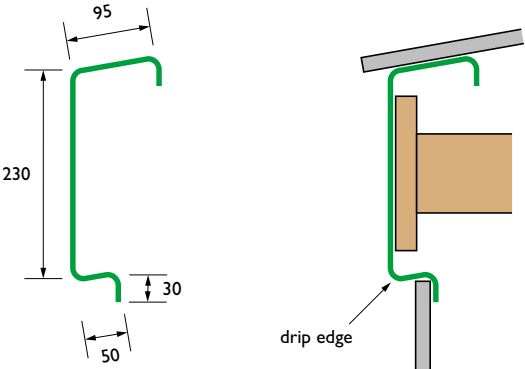

Bottom of Wall

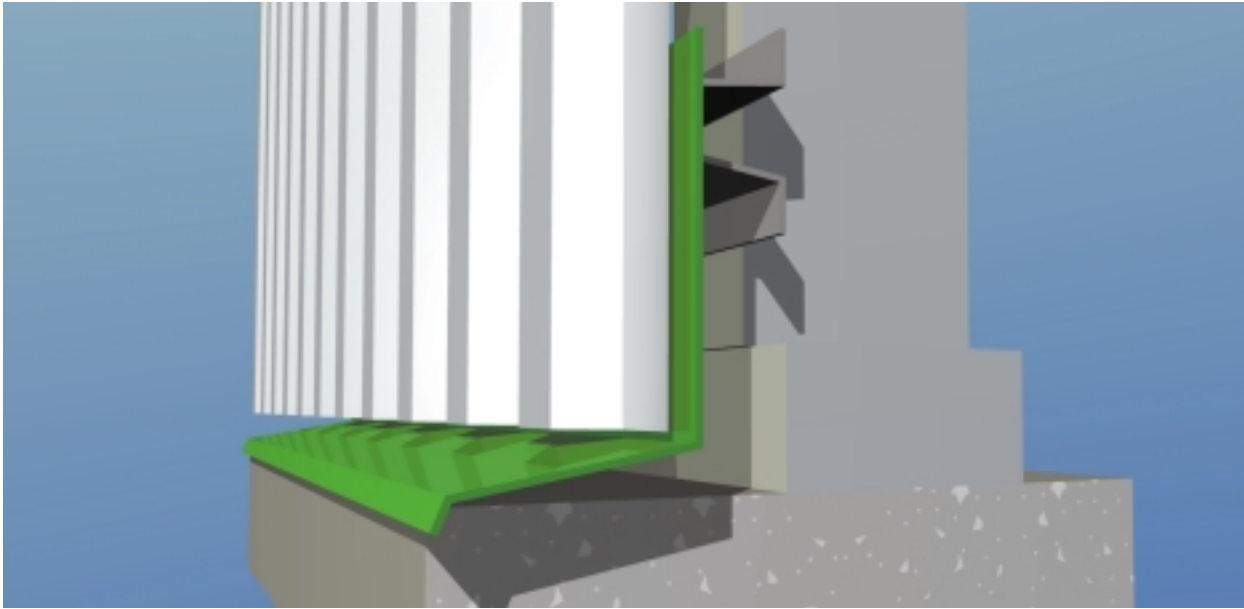

Flashing at wall footings should include a fall on 'horizontal' planes and be of sufficient size to ensure good drainage away from the sheeting and to avoid potential build-up of debris.

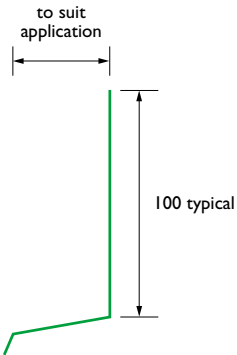
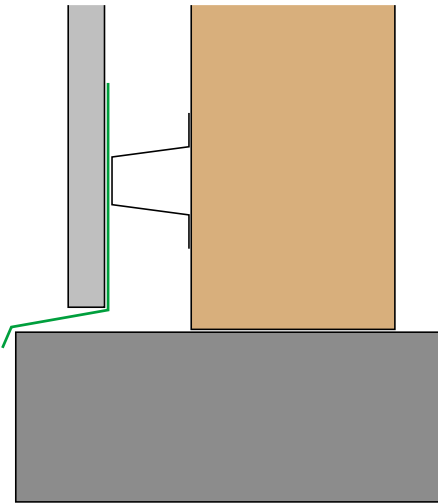
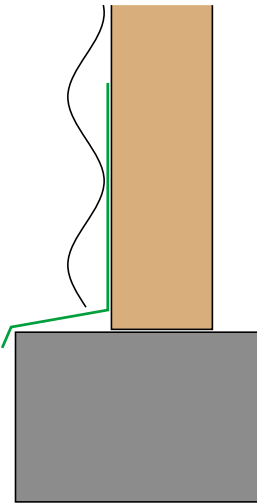

Material choice for this flashing is important as water will regularly drip on to flashing from wall cladding.

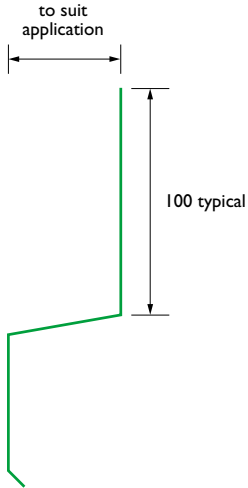
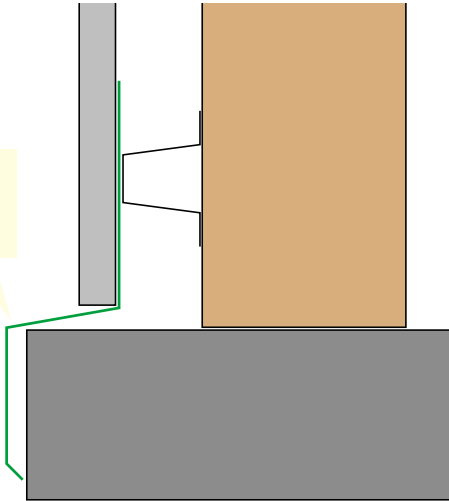

Window / Door

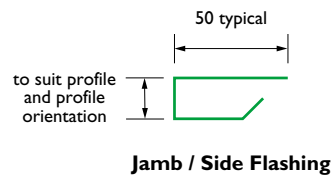
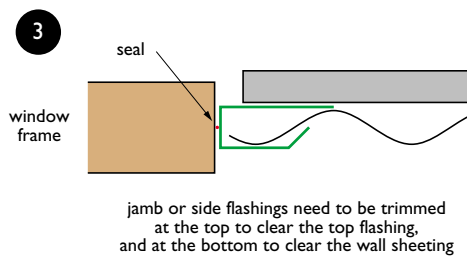
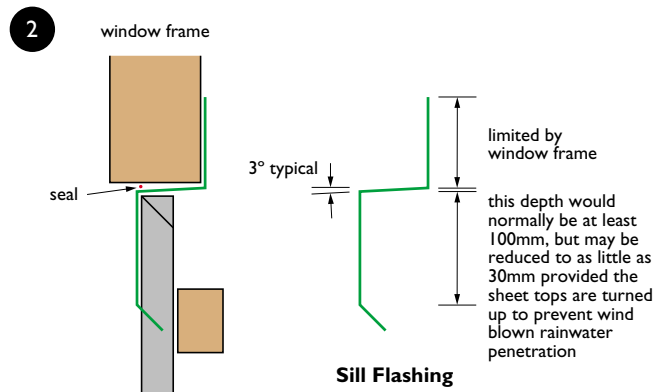
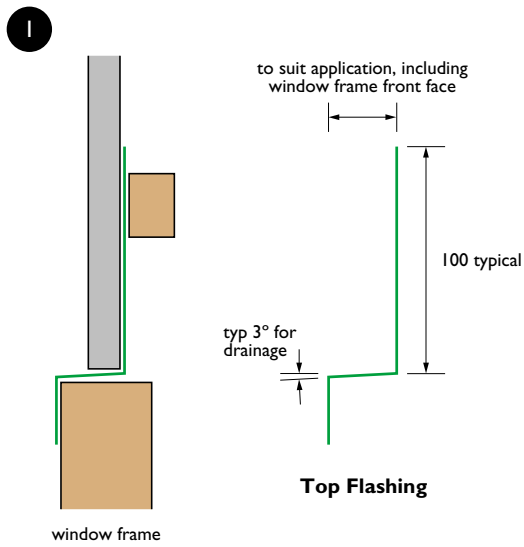
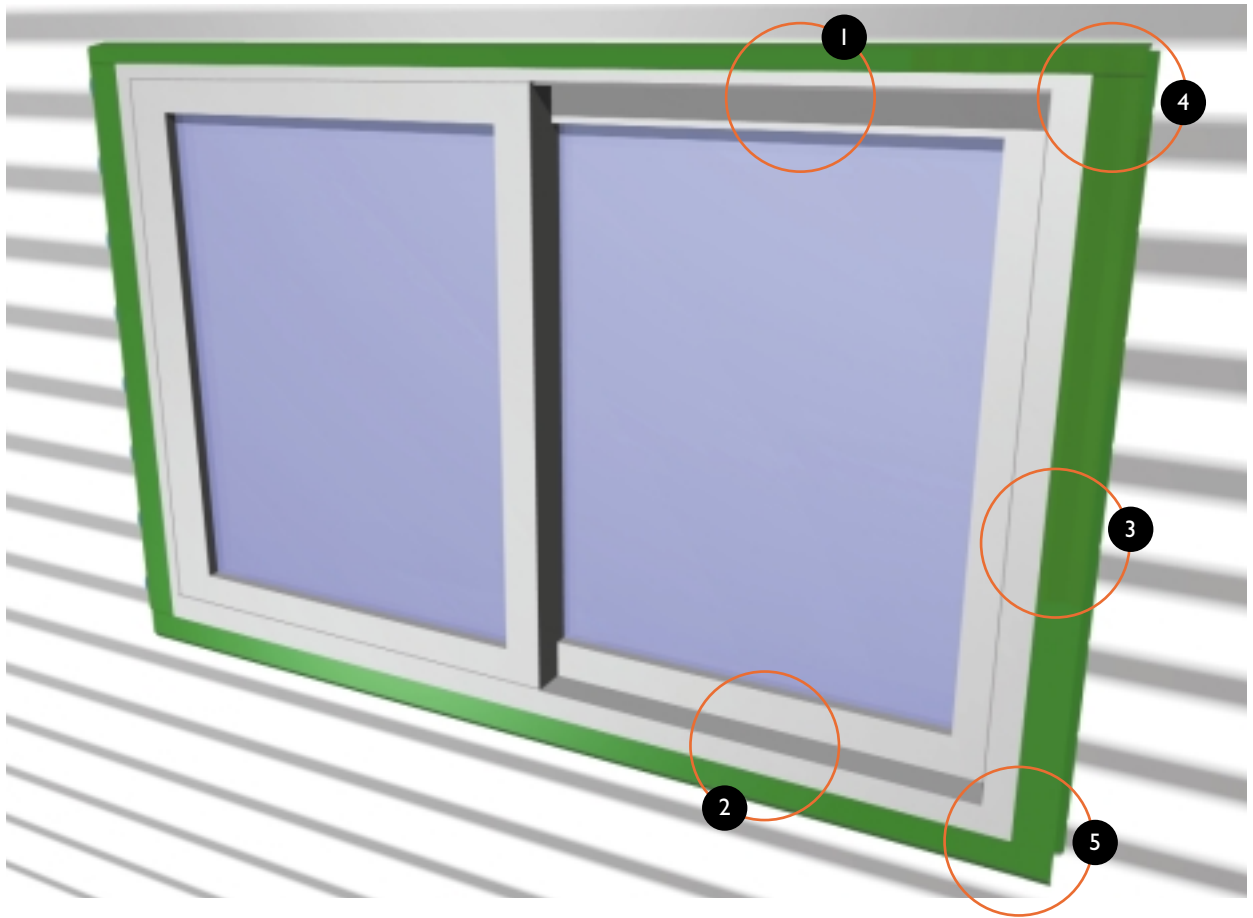

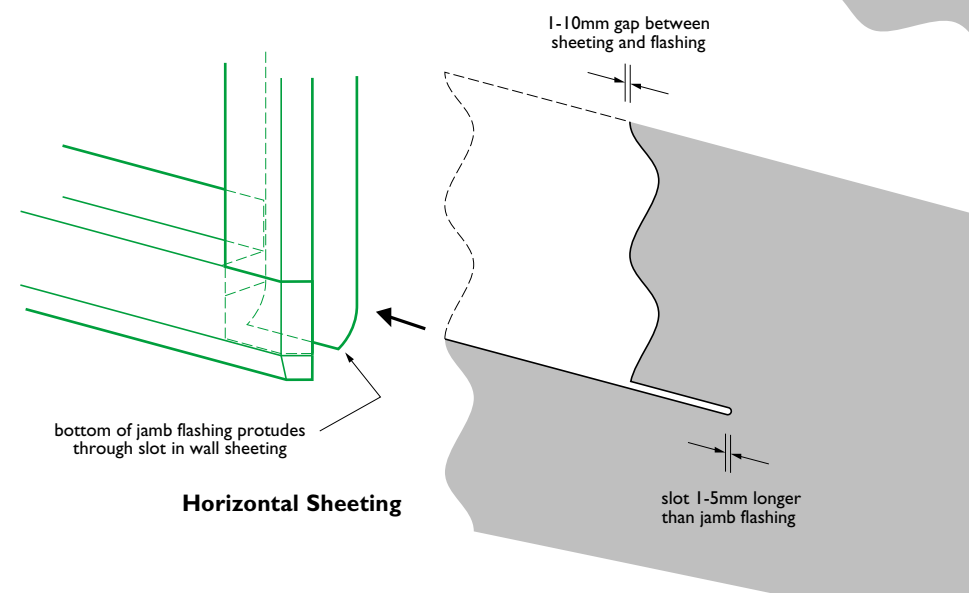
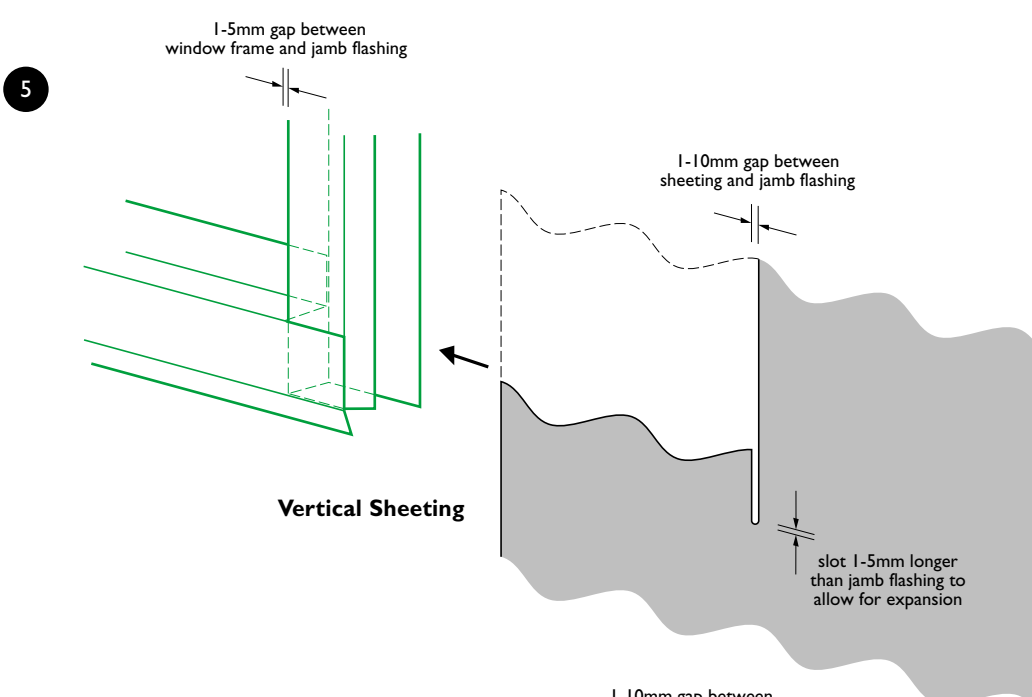
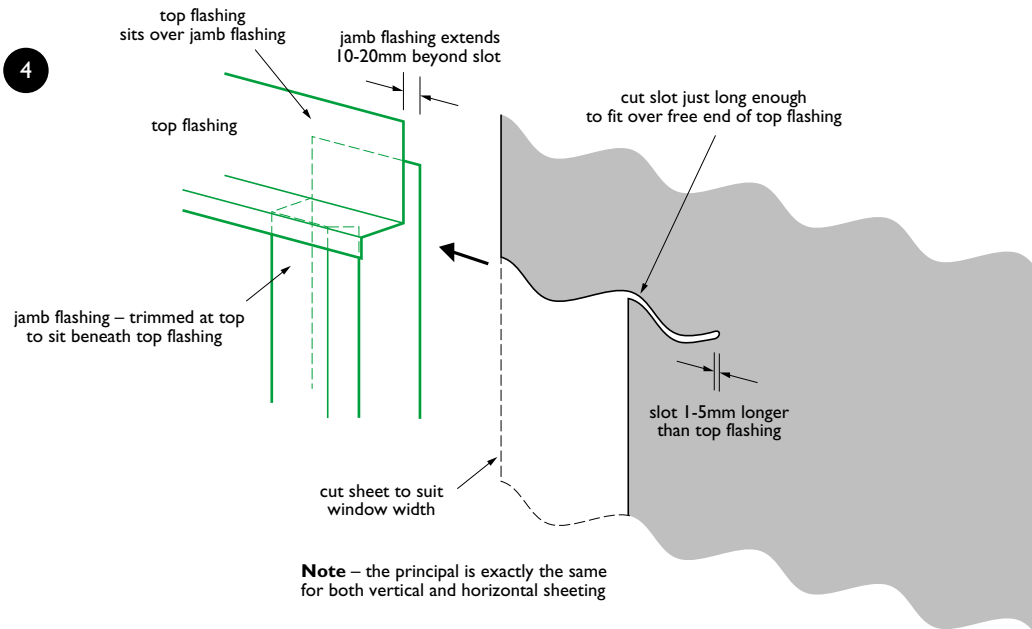

Wall Penetrations

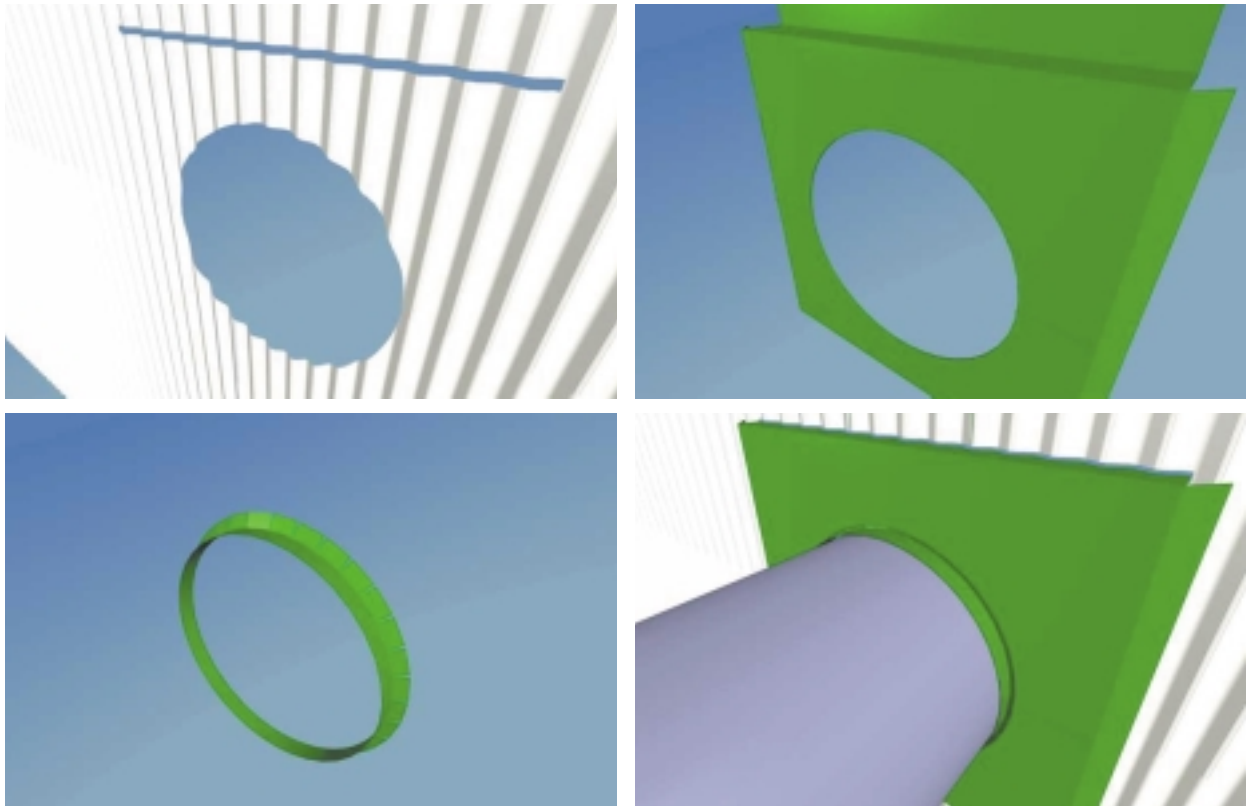

Larger wall penetrations can be treated in a number of ways. One option starts with a clearance hole for the penetrating object plus a slot placed above (and wider than) the hole. With this arrangement the flashing remains outside the wall sheeting except above the slot.

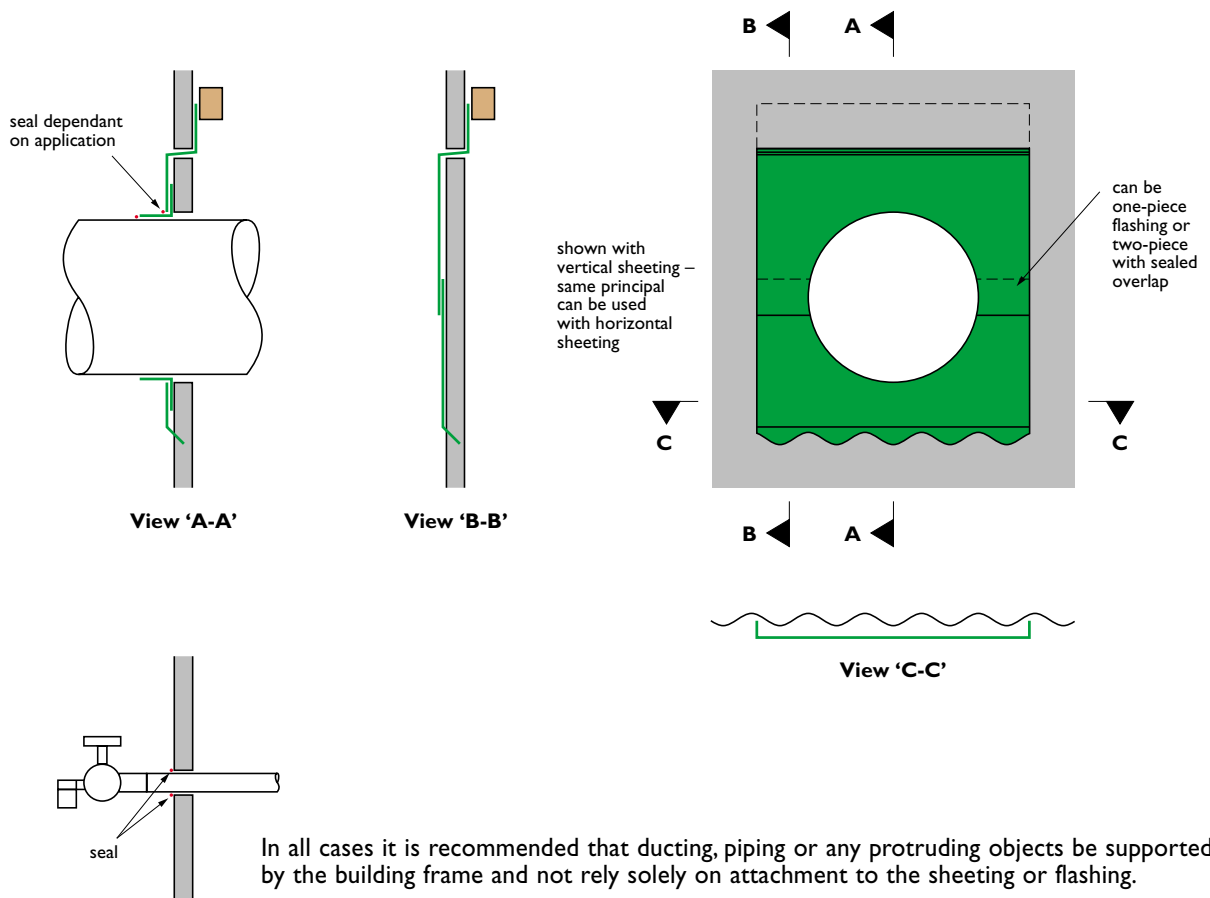

In all cases it is recommended that ducting, piping or any protruding objects be supported by the building frame and not rely solely on attachment to the sheeting or flashing.

Stramit® Product Range

Stramit offers a comprehensive range of building products throughout Australia. These include:

- Roof sheeting
- Roof decking
- Wall cladding
- Purlins and girts
- Top hats and battens
- Specialist rainwater goods
- Composite slab decking

Other Stramit Literature

In addition to individual technical manuals for all products or product groups, Stramit offers a range of Design Guides to assist architects, engineers and specifiers:

- Limit-State Design
- Roof System Selection
- Concealed Fixed Decking
- Roof Slope
- Foot Traffic (on metal roofs)
- Spring Curving
- Premium Materials and Finishes

Please contact your nearest Stramit office to obtain copies of these items.



The Stramit web page can be found at:

www.stramit.com.au

Details of many Stramit® products can also be seen on the RAlA site 'Product Selector' at:

www.selector.com.au

Building Products

		prices	availability	general	technical
contact numbers for information			products coating colours	other	advice product data
SYDNEY 26-28 Frank Street, Wetherill Park NSW 2164	phone fax	(02) 9757 0909 (02) 9757 0988		(02) 9757 0900 (02) 9757 0977	
CANBERRA 4 Bass Street, Queanbeyan NSW 2620	phone fax	(02) 6297 3533 (02) 6297 8089			
COFFS HARBOUR 6 Mansbridge Drive, Coffs Harbour NSW 2450	phone fax	(02) 6652 6333 (02) 6651 3395			(02) 9757 0900 (02) 9757 0977
NEWCASTLE 17 Nelson Road, Cardiff NSW 2285	phone fax	(02) 4954 5033 (02) 4954 5856			
ORANGE 51 Leewood Drive, Orange NSW 2800	phone fax	(02) 6361 0444 (02) 6361 9814			
MELBOURNE - KILSYTH 180-186 Colchester Road, Kilsyth VIC 3137	phone fax	(03) 9721 8333 (03) 9761 4133		(03) 9721 8333 (03) 9721 8247	
MELBOURNE - BAYSWATER 491 Mountain Highway, Bayswater VIC 3153	phone fax	(03) 9722 5500 (03) 9722 5538			
MELBOURNE - MULGRAVE 2 Faigh Street, Mulgrave VIC 3170	phone fax	(03) 9560 1588 (03) 9560 7840		(03) 9560 1588 (03) 9560 4606	
MELBOURNE - PRESTON 219 Dundas Street, Preston VIC 3072	phone fax	(03) 9484 0193 (03) 9484 5060			
ALBURY 109 Boronia Street, Albury NSW 2640	phone fax	(02) 6025 2133 (02) 6025 6349			(03) 9560 1588 (03) 9560 4606
BENDIGO Ramsay Court, Kangaroo Flat VIC 3555	phone fax	(03) 5447 8455 (03) 5447 9677			
HOBART Farley Street, Derwent Park TAS 7010	phone fax	(03) 6272 4500 (03) 6272 0967			
SOUTH AUSTRALIA 2 Maritime Court, Gillman SA 5013	phone fax	(08) 8447 7111 (08) 8447 2700			
BRISBANE 57-71 Platinum Street, Crestmead QLD 4132	phone fax	(07) 3803 9999 (07) 3803 1499			
TOWNSVILLE 402-408 Bayswater Road, Garbutt QLD 4814	phone fax	(07) 4779 0844 (07) 4775 7155			
CAIRNS 83 Kenny Street, Portsmith QLD 4870	phone fax	(07) 4031 4064 (07) 4031 4069			
MACKAY Brickworks Court, Glenella QLD 4740	phone fax	(07) 4942 3488 (07) 4942 2343			(07) 3803 9999 (07) 3803 1499
MARYBOROUGH 10 Activity Street, Maryborough QLD 4650	phone fax	(07) 4121 2433 (07) 4123 3139			
ROCKHAMPTON 174-176 Alexandra St, Nth Rockhampton QLD 4701	phone fax	(07) 4927 3855 (07) 4922 2857			
DARWIN 55 Albatross Street, Winnellie NT 0820	phone fax	(08) 8947 0780 (08) 8947 1577			
PERTH 21 Alloa Street, Maddington WA 6109	phone fax	(08) 9493 8800 (08) 9493 8899			
BUNBURY Lot 1 Proffit Street, Bunbury WA 6230	phone fax	(08) 9721 8046 (08) 9721 8017			